

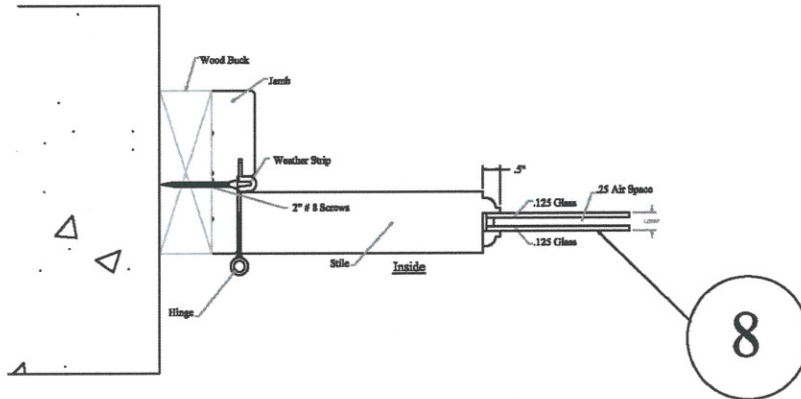

ASTM E330 PERFORMANCE TESTING
HARWOOD GLAZED WIDE MUNTIN TDL PANEL WOOD DOORS (IN - SWING)
REPORT #CCLI-18-027

April 10, 2018
Drawing Pg. 13

 CONSTRUCTION
CONSULTING
LABORATORY,
INTERNATIONAL
1601 Luna Road
Carrollton, Texas 75006
Phone (972) 242-0556
Report# CCLI-18-027, Date 3-21-2018
Reviewed BY EA



Ⓒ Anchor Section

Glass*Craft

Hardwood Glazed Wide Muntin TDL Doors



ASTM E330 PERFORMANCE TESTING
 HARWOOD GLAZED WIDE MUNTIN TDL PANEL WOOD DOORS (IN - SWING)
 REPORT #CCLI-18-027

April 10, 2018
 Drawing Pg. 14

CCL CONSTRUCTION
 CONSULTING
 LABORATORY,
 INTERNATIONAL
 1601 Luna Road
 Carrollton, Texas 75006
 Phone (972) 242-0556
 Report #18-027, Date 3-21-2018
 Reviewed BY EA

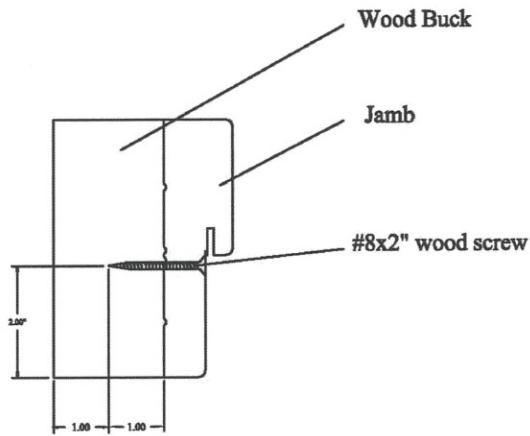

Ⓒ1 Anchor Detail

Glass*Craft
 Hardwood Glazed Wide Muntin TDL Doors



ASTM E330 PERFORMANCE TESTING
HARWOOD GLAZED WIDE MUNTIN TDL PANEL WOOD DOORS (IN - SWING)
REPORT #CCLI-18-027

April 10, 2018
Drawing Pg. 15

 CONSTRUCTION
CONSULTING
LABORATORY,
INTERNATIONAL
1601 Luna Road
Carrollton, Texas 75006
Phone (972) 242-0556
Report # 18-027, Date 3-21-2018
Reviewed BY EA

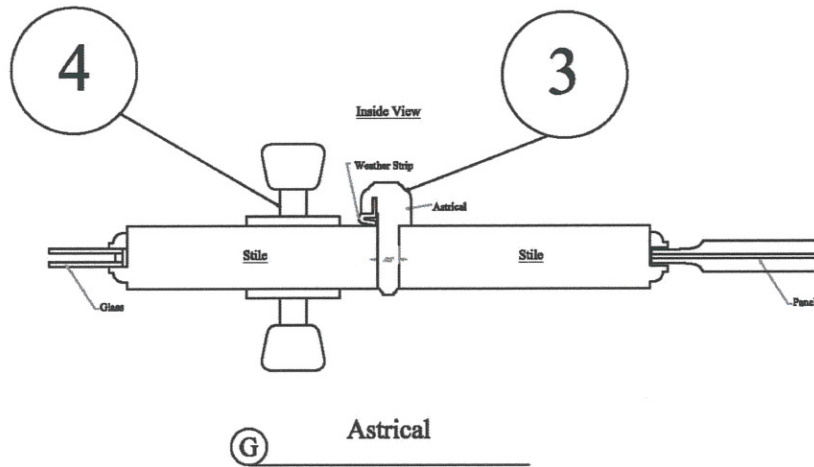

Glass*Craft

Hardwood Glazed Wide Muntin TDL Doors



ASTM E330 PERFORMANCE TESTING
 HARWOOD GLAZED WIDE MUNTIN TDL PANEL WOOD DOORS (IN - SWING)
 REPORT #CCLI-18-027

April 10, 2018
 Drawing Pg. 16

CONSTRUCTION CONSULTING LABORATORY INTERNATIONAL
 1601 Luna Road
 Carrollton, Texas 75006
 Phone (972) 242-0556
 Report # 18-027, Date 3-21-2018
 Reviewed BY EA

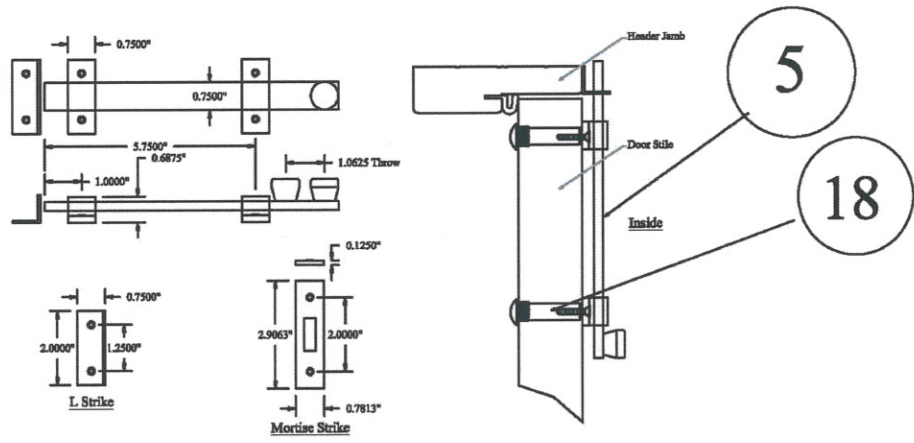

(F) Surface Bolt

Glass*Craft

Hardwood Glazed Wide Muntin TDL Doors



ASTM E330 PERFORMANCE TESTING
HARWOOD GLAZED WIDE MUNTIN TDL PANEL WOOD DOORS (IN - SWING)
REPORT #CCLI-18-027

April 10, 2018
Drawing Pg. 17

 CONSTRUCTION
CONSULTING
LABORATORY,
INTERNATIONAL
1601 Luna Road
Carrollton, Texas 75006
Phone (972) 242-0556
Report # 18-027, Date 3-21-2018
Reviewed BY EA

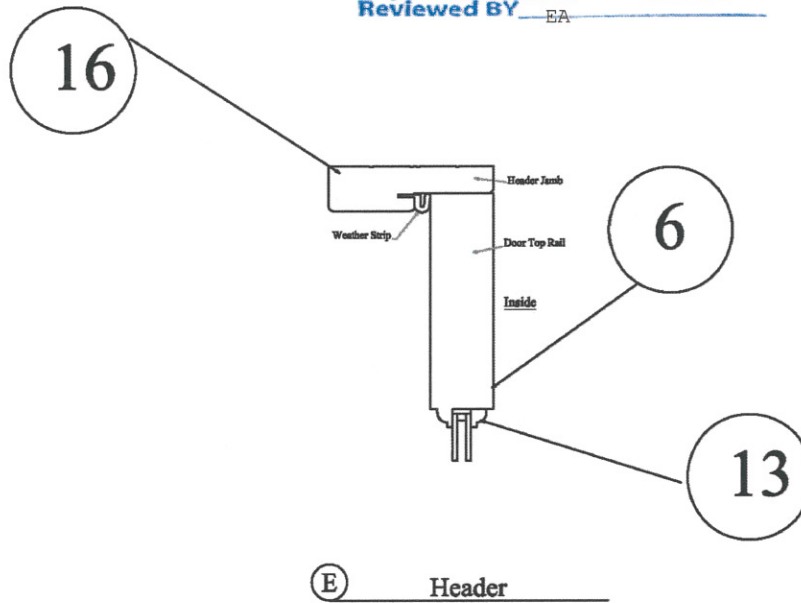

Glass*Craft

Hardwood Glazed Wide Muntin TDL Doors



ASTM E330 PERFORMANCE TESTING
HARWOOD GLAZED WIDE MUNTIN TDL PANEL WOOD DOORS (IN - SWING)
REPORT #CCLI-18-027

April 10, 2018
Drawing Pg. 18

 CONSTRUCTION
CONSULTING
LABORATORY,
INTERNATIONAL
1601 Luna Road
Carrollton, Texas 75006
Phone (972) 242-0556
Report # 18-027, Date 3-21-2018
Reviewed BY EA

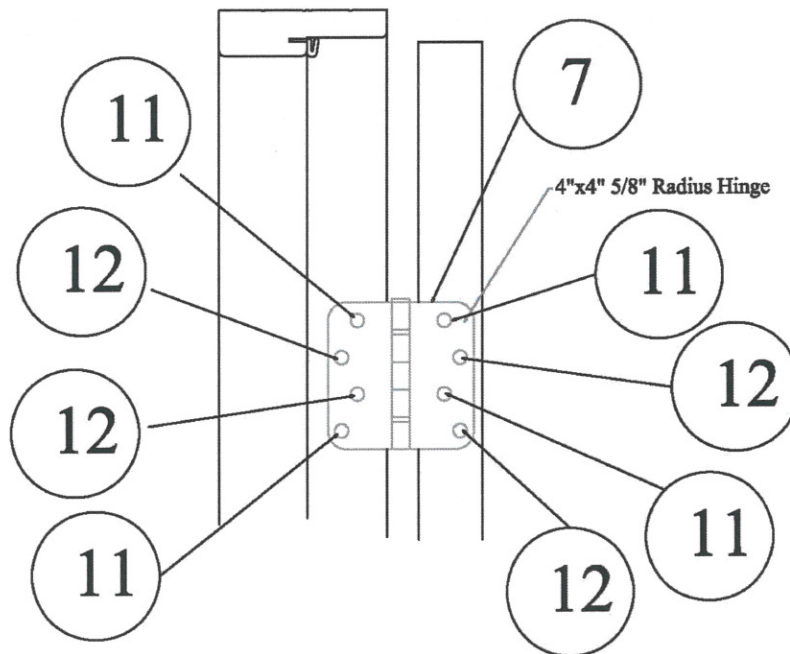

Ⓓ Door Hinge

Glass*Craft

Hardwood Glazed Wide Muntin TDL Doors



ASTM E330 PERFORMANCE TESTING
HARWOOD GLAZED WIDE MUNTIN TDL PANEL WOOD DOORS (IN - SWING)
REPORT #CCLI-18-027

April 10, 2018
Drawing Pg. 19

 CONSTRUCTION
CONSULTING
LABORATORY,
INTERNATIONAL
1601 Luna Road
Carrollton, Texas 75006
Phone (972) 242-0556
Report# 18-027, Date 3-21-2018
Reviewed BY EA

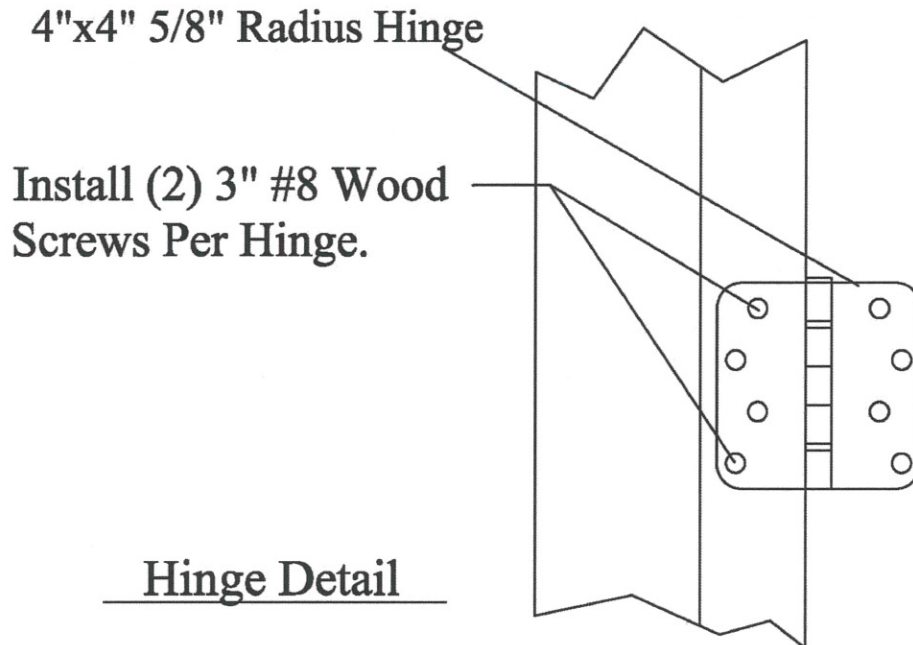

Glass*Craft

Hardwood Glazed Wide Muntin TDL Doors



ASTM E330 PERFORMANCE TESTING
HARWOOD GLAZED WIDE MUNTIN TDL PANEL WOOD DOORS (IN - SWING)
REPORT #CCLI-18-027

April 10, 2018
Drawing Pg. 20

 CONSTRUCTION
CONSULTING
LABORATORY,
INTERNATIONAL
1601 Luna Road
Carrollton, Texas 75006
Phone (972) 242-0556
Report # 18-027, Date 3-21-2018
Reviewed BY EA

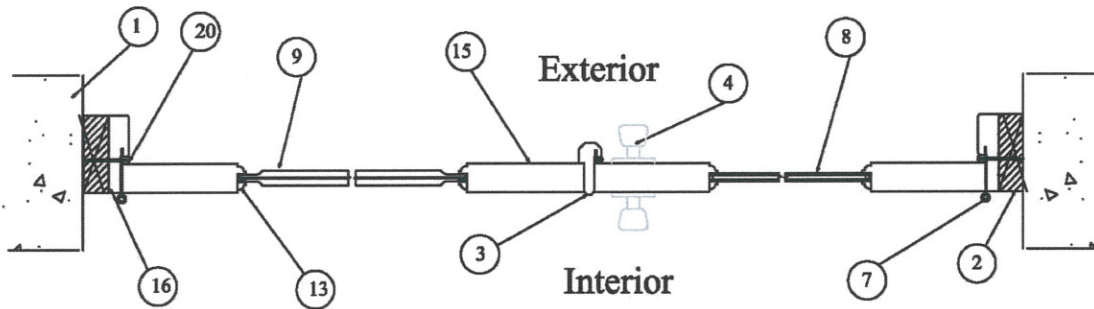

Horizontal Cross Section

Glass*Craft

Hardwood Glazed Wide Muntin TDL Doors



ASTM E330 PERFORMANCE TESTING
HARWOOD GLAZED WIDE MUNTIN TDL PANEL WOOD DOORS (IN - SWING)
REPORT #CCLI-18-027

April 10, 2018
 Drawing Pg. 21

List of Material

Item #	Description	Material
1	Masonry	CONC.
2	2x Back	Wood
3	Astrical	Wood
4	Lock Set	Metal
5	Surface Bolt	Metal
6	Top Header	Wood
7	4"x4" 5/8" Radius Hinge	Metal
8	Panel	Glass
9	Panel	Wood
10	Sill Inswing	Alum.
11	2" x #8 Wood Screw	Metal
12	1" x #9 PFH Wood Screw	Metal
13	Quarter Round Trim	Wood
14	Mull	Wood
15	Stile	Wood
16	Door Jamb	Wood
17	Door Bottom	Rubber
18	10-32 Sex Bolt	Metal
19	Bottom Rail	Wood
20	Weather Strip	Foam

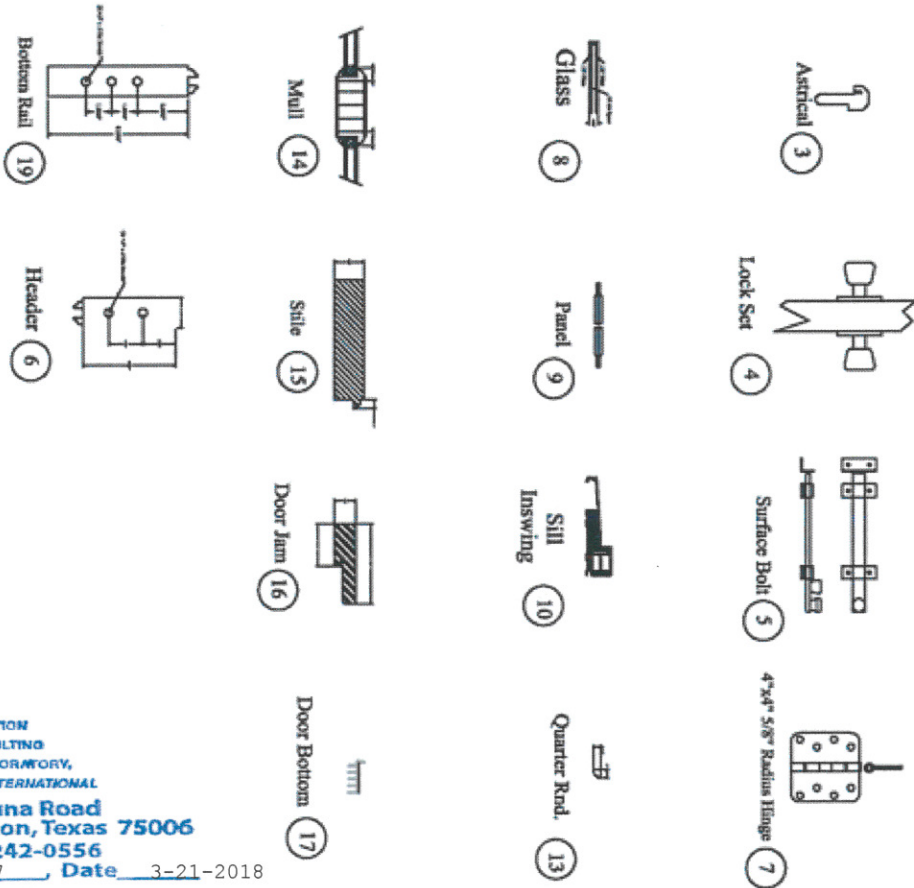

CONSTRUCTION CONSULTING LABORATORY INTERNATIONAL
 1601 Luna Road
 Carrollton, Texas 75006
 Phone (972) 242-0556
 Report # 18-027, Date 3-21-2018
 Reviewed BY EA



ASTM E330 PERFORMANCE TESTING
 HARWOOD GLAZED WIDE MUNTIN TDL PANEL WOOD DOORS (IN - SWING)
 REPORT #CCLI-18-027

April 10, 2018
 Drawing Pg. 22

Quarter Rnd. Trim (13)



Astrical (3)

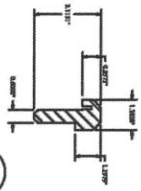

Bottom Rail (19)

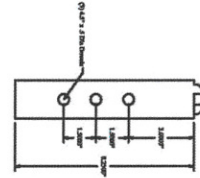

CONSTRUCTION CONSULTING LABORATORY INTERNATIONAL
 1601 Luna Road
 Carrollton, Texas 75006
 Phone (972) 242-0556
 Report # 18-027 Date 3-21-2018
 Reviewed BY EA

Mull (14)

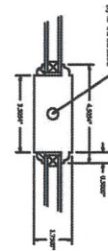

Stile (15)

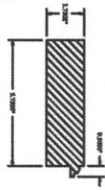

Door Jamb (16)



Header (6)

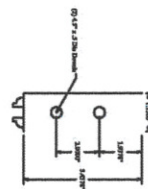

Panel (9)



Glass*Craft
 Hardwood Glazed Wide Muntin TDL Doors



ASTM E330 PERFORMANCE TESTING
HARWOOD GLAZED WIDE MUNTIN TDL PANEL WOOD DOORS (IN - SWING)
REPORT #CCLI-18-027

April 10, 2018
Drawing Pg. 23

CONSTRUCTION CONSULTING LABORATORY INTERNATIONAL
1601 Luna Road
Carrollton, Texas 75006
Phone (972) 242-0556
Report # CCLI-18-027, Date 3-21-2018
Reviewed BY EA

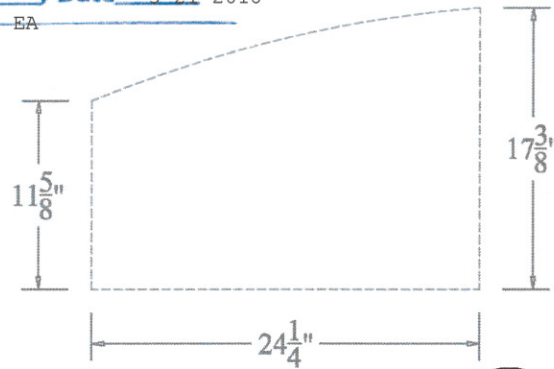

Glass Panel

8

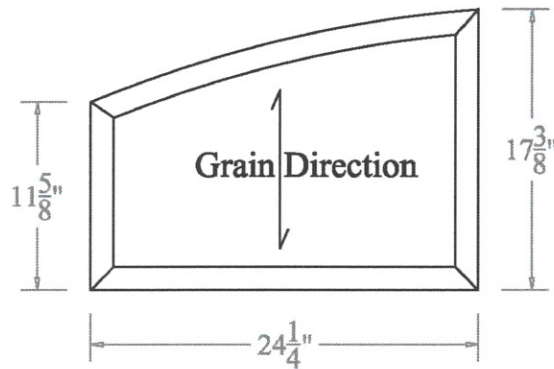

Wood Panel

9

Glass*Craft
Hardwood Glazed Wide Muntin TDL Doors



ASTM E330 PERFORMANCE TESTING
HARWOOD GLAZED WIDE MUNTIN TDL PANEL WOOD DOORS (IN - SWING)
REPORT #CCLI-18-027

April 10, 2018
Drawing Pg. 24

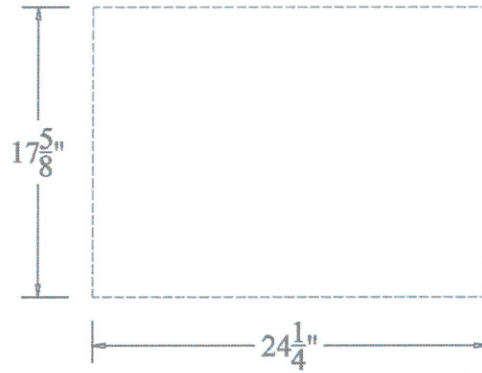

Glass Panel

8

 CONSTRUCTION
CONSULTING
LABORATORY,
INTERNATIONAL
1601 Luna Road
Carrollton, Texas 75006
Phone (972) 242-0556
Report # 18-027, Date 3-21-2018
Reviewed BY EA

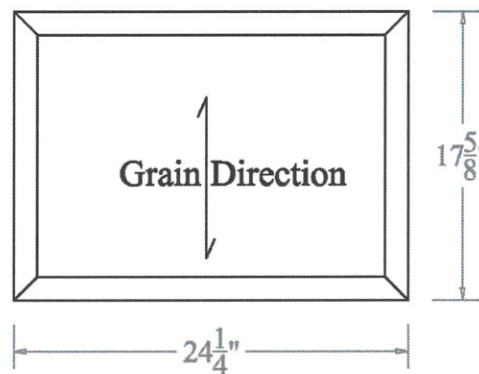

Wood Panel

9

Glass*Craft

Hardwood Glazed Wide Muntin TDL Doors

- END OF REPORT -